

**cemp**<sup>®</sup>

Flameproof  
Motors

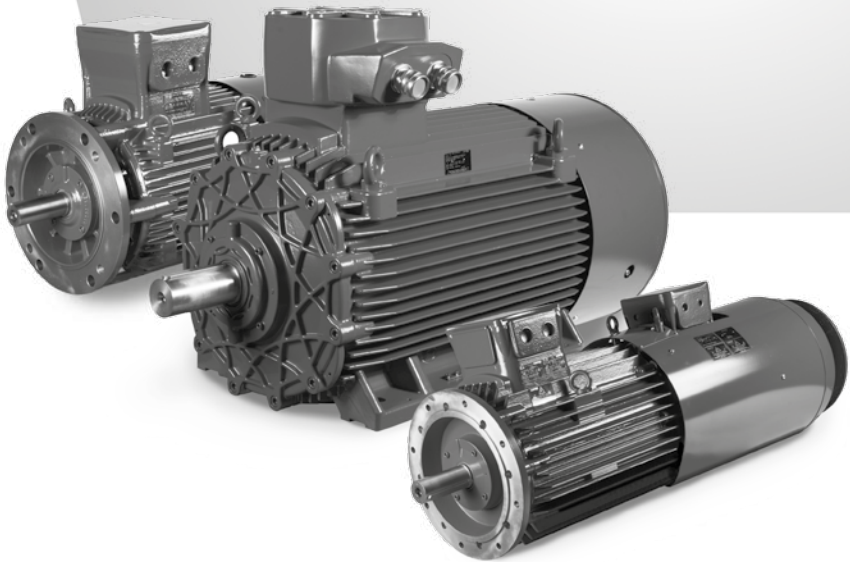

## Electric Motors

Instructions for use and maintenance

A Regal Brand

**REGAL**<sup>®</sup>

# CONTENTS

	Page
<b>Introduction</b> .....	20
<b>Note regarding electro-magnetic compatibility</b> .....	20
<b>1. General safety warnings</b> .....	21
1.1 Danger .....	21
<b>2. Storage and installation</b> .....	23
2.1 Control .....	23
2.2 Storage procedure .....	23
2.3 Installation .....	23
<b>3. Putting into operation</b> .....	26
3.1 Initial Controls .....	26
3.2 Control of Design Data .....	26
3.3 Starting .....	27
3.4 Conditions of Use .....	27
<b>4. Maintenance</b> .....	28
4.1 Inspection .....	28
4.2 Lubrication .....	28
4.3 Dismantling and Reassembling the Motor .....	29
4.4 Replacing the Bearings .....	29
4.5 Overhauls and Repairs .....	29
<b>5. Troubleshooting</b> .....	30
<b>Table</b> .....	33

## Introduction

The electrical machines referred to in these instructions are intended as components for use in industrial areas. The information contained in this documentation is designed for use by qualified personnel who are familiar with the current rules and regulations in force. They are not intended to replace any installation regulations issued for safety purposes.

In terms of Directive 89/392/CEE low voltage motors are to be considered as **components** to be installed on machines. **Commissioning** is forbidden until the final product has been checked for conformity.

### Note regarding electro-magnetic compatibility

Low voltage induction motors, if installed correctly and connected to the power supply, respect all immunity and emission limits as set out in the regulations relating to electro-magnetic compatibility (EMC “Generic Standard” for industrial environments). In the case of supply by means of electronic impulse (inverters, soft starters etc.), all verifications and any modifications necessary to ensure that emission and immunity limits stated within the regulations are respected, are the responsibility of the installer.

### Motors for classified areas

Motors to be used in dangerous areas are designed in compliance with European standards, using protection methods that are suitable for guaranteeing safety in areas subject to risk of fire and explosion.

Where these motors are used improperly or modified their safety may be impaired. See the “Safety Instructions” manual.

# 1. General safety warnings

## 1.1 Danger

Rotating electric machines are dangerous.

Consequently:

- **improper use**
- **removal of protection** and disconnection of protection devices
- **lack of inspection and maintenance** can cause serious harm.

**The personnel must be informed of any danger caused by contact with:**



- **live parts**



- **rotating parts**



- **hot surfaces.** In normal working conditions the motor exceeds 50 °C.

The safety manager must ensure and guarantee that:

- the machine is moved, installed, put in service inspected, maintained and repaired **only by qualified personnel**, who should have:
  - specific technical training and experience
  - knowledge of technical standards and applicable laws
  - knowledge of general safety regulations as well as national, local and installation regulations
  - ability to recognize and avoid all possible dangers.

**Work on the electric machine should be carried out upon authorization of the safety manager** after having ensured that:

- a) the motor has been disconnected from the power supply and that no parts of the motor including auxiliary parts are live
- b) **discharge of the capacitor** has been done for single phase motors
- c) the motor is completely stopped and there is no danger of **accidental restarting**
- d) the right precautions against faulty braking operations have been taken for **self-braking motors**



where thermal protection with automatic reset is used care must be taken to ensure automatic restart cannot occur. Since the electric machine referred to is intended to be used in industrial areas, **additional protective measures must be taken and guaranteed by the person who is in charge of installation where more stringent protective measures are needed.**



Cemp has its own program for the Authorized Repair Shops to select the facilities, provide training courses, issue certificates of participation, release logo and recognition sign to the qualified companies.

Wherever it is possible we recommend the users to address our network of Authorized Repairers, which updated list can be found at the "Organization" page of our website: [www.cemp.eu](http://www.cemp.eu)

## Standards and specifications

Title	INTERNATIONAL	EU	I	GB	F	D
	IEC	CENELEC	CEI-EN	BS	NFC	DIN/VDE
Electrical rotating machines/rated operation and characteristic data	IEC 60034-1	EN 60034-1	CEI-EN 60034-1 (CEI 2-3)	BS 4999-1 BS 4999-69	NFC 51-100 NFC 51-111	VDE 0530-1
Methods for determining losses and efficiency of rotating electrical machinery	IEC 60034-2	EN 60034-2	CEI-EN 60034-2 (CEI 2-6)	BS 4999-34	NFC 51-112	VDE 0530-2
Protection types of rotating electrical machines	IEC 60034-5	EN 60034-5	CEI-EN 60034-5 (CEI 2-16)	BS 4999-20	NFC 51-115	VDE 0530-5
Cooling methods of rotating electrical machines	IEC 60034-6	EN 60034-6	CEI-EN 60034-6 (CEI 2-7)	BS 4999-21	IEC 34-6	DIN IEC 34-6
Construction types of rotating electrical machines	IEC 60034-7	EN 60034-7	CEI-EN 60034-7 (CEI 2-14)	BS 4999-22	NFC 51-117	DIN IEC 34-7
Terminal markings and direction of rotation for electrical machines	IEC 60034-8	EN 60034-8	CEI 2-8	BS 4999-3	NFC 51-118	VDE 0530-8
Noise emission, limit values	IEC 60034-9	EN 60034-9	CEI-EN 60034-9 (CEI 2-24)	BS 4999-51	NFC 51-119	VDE 0530-9
Start-up behaviour of squirrel-cage motors at 50 Hz up to 660V	IEC 60034-12	EN 60034-12	CEI-EN 60034-12 (CEI 2-15)	BS 4999-112	IEC 34-12	VDE 0530 12
Vibration severity of rotating electrical machines	IEC 60034-14	EN 60034-14	CEI-EN 60034-14 (CEI 2-23)	BS 4999-50	NFC 51-111	DIN ISO 2373
Fixing dimensions and outputs for IM B3	IEC 60072	EN 50347	IEC 60072	BS 4999-10	NFC 51-104/110	DIN 42673
Fixing dimensions and outputs for IM B5, IM B14	IEC 60072	EN 50347	IEC 60072	BS 4999-10	NFC 51-104/110	DIN 42677
Cylindrical shaft ends for electrical machines	IEC 60072	EN 50347	IEC 60072	BS 4999-10	NFC 51-111	DIN 748-3
Electrical equipment for hazardous areas General provisions	IEC 60079-0	EN 60079-0	(CEI 31-8)	BS 5501-1	NFC 23-514	VDE 0171-1
Electrical equipment for hazardous areas Flame-proof enclosure "d"	IEC 60079-1	EN 60079-1	(CEI 31-1)	BS 5501-5	NFC 23-518	VDE 0171-5
Electrical equipment for hazardous areas Increased safety "e"	IEC 60079-7	EN 60079-7	(CEI 31-7)	BS 5501-6	NFC 23-519	VDE 0171-6
Checking and maintenance of electrical systems in places in danger of explosion due to the presence of gas	IEC 60079-17	EN 60079-17	CEI EN 60079-17	----	----	----
Electrical systems in places in danger of explosion due to the presence of gas	IEC 60079-14	EN 60079-14	CEI EN 60079-14	----	----	----
Classification of dangerous places due of the presence of gas	IEC 60079-10	EN 60079-10	CEI EN 60079-10	----	----	----
Checking and maintenance of electrical systems in places in danger of explosion due to the presence of dust	IEC 61241-17	EN 61241-17	CEI EN 61241-17	----	----	----
Electrical systems in places in danger of explosion due to the presence of dust	IEC 61241-14	EN 61241-14	CEI EN 61241-14	----	----	----
Classification of dangerous places due of the presence of dust	IEC 61241-10	EN 61241-10	CEI EN 61241-10	----	----	----

## 2. Storage and installation

### 2.1 Control

The motors are shipped ready for installation. Upon receipt remove packaging and turn the shaft to check the motor has not been damaged, also check all physical aspects of the machine for damage. In the case where the machine is damaged an immediate notification must be given in writing by the storeman and the representative of the carrier to Cemp within 3 days.

### 2.2 Storage procedure

#### 2.2.1 Storage conditions

If the motors are not used immediately, they should be stored in a clean, dry temperate environment free of vibrations and protected from the weather. (If stored below  $-15\text{ }^{\circ}\text{C}$ , and before starting, the motor temperature must be restored to the permissible working temperature range (i.e.  $-15\text{ }^{\circ}\text{C} \rightarrow 40\text{ }^{\circ}\text{C}$ ). **In this case, it is necessary to specify these particular storage conditions during the ordering stage so that proper precautions can be taken during building and packaging.**

#### 2.2.2 Checking bearings

When the motors are stored properly, bearings need, no maintenance. However, it is a good idea to turn the shaft by hand every three months. After storage of over one year motors with unshielded bearings (usually such motors have a lubricator and bear a lubrication plate), it is advisable to check the condition of the lubrication and motor components.

#### 2.2.3 Checking insulation

Before installation check the motor windings using the appropriate instruments to ensure the condition of the insulation between phases and between phase and earth are of the corrects resistance values.

 Do not touch the terminals during and immediately after measuring as they are live.



If the insulation resistance value is less than 10 megaohm, or after storage in a damp environment, the motors must be dried in an oven for about 8 hours by gradually bringing the temperature up to  $100\text{ }^{\circ}\text{C}$ . To ensure that the dampness has been completely expelled, the motors must be dismantled.

#### 2.2.4 Operating precautions

All operations listed above must be carried out by qualified personnel. In case of flame-proof motors it is necessary:

- to be very careful that the flame-proof characteristics are not altered
- to have the procedure described in point 2.2.2 carried out by authorized repair shops
- to be aware that dismantling or opening of the motor during the warranty period without authorization of Cemp may invalidate the warranty.

### 2.3 Installation

  **Work on the electric machine must be carried out when the machine has stopped and been disconnected from the power supply** (including auxiliary parts, such as anticondensation heaters).

#### 2.3.1 Lifting

Before using the lifting rings make sure they have been tightened.

 **The lifting rings are big enough to bear the weight of a single motor, therefore they must not be used to lift the equipment connected to the motor.**

In environments where the temperature is below  $-20\text{ }^{\circ}\text{C}$ , these lifting rings should be used with caution as they could break at low temperatures and cause damage.

#### 2.3.2 Assembly of connecting device

Fitting pulley, coupling or gear to the motor shaft must be carried out with care to ensure no damage is caused to the bearing. Remove the protective paint finish from the shaft and smear with oil then fit the device, heating before fitting if possible to ensure an easy fit.

Any component that is assembled on the motor shaft must be accurately balanced.

The motor is normally balanced using a half key and the letter H is punched on the shaft.

Fitments not balanced properly can cause anomalous vibrations during operation that jeopardises the proper working of the motor and drastically reduces its life.

### 2.3.3 Direct connection

Use couplings that have been made and balanced perfectly align the motor shaft and the operating machine precisely. **Inaccurate alignment may cause vibrations and damage to the bearings or breakage of the shaft end.**

### 2.3.4 Connection by means of pulley

Check that alignment with the pulley of the operating machine has been carried out perfectly. The tension of the belts must be enough to avoid slipping. Excessive tension of the belts causes harmful radial loads on the motor shaft and bearings, reducing their life.

It is advisable to assemble the motor on belt-tensioning slides in order to regulate tension of the belts exactly.

 Connection with belts must be such as to avoid accumulation of static charges in the moving belts which could cause sparks.

### 2.3.5 Connection to power supply

Use cables with sufficient section to bear the maximum current absorbed by the motor, avoiding overheating and/or drops in voltage. Connect the cables to terminals by following the instructions on the plate or on the diagram included in the terminal box. Check that terminal nuts are tightened.

 **Connections to the terminals must be made in order to guarantee safe distances between live uncovered parts.**

 Earthing is through the screw located inside the terminal box. Flame-proof motors are provided with a second earth stud located on the motor casing outside the terminal box. **Earths must be of sufficient size and installed according to relevant standards.** The area of contact of connections must be cleaned and protected against corrosion.

When the cable inlet is made by means of a cable gland, it must be chosen properly in relation to the type of plant and type of cable used. The cable gland must be tightened so that the retaining rings create the pressure necessary to:

- a) prevent transmission of mechanical stress to the motor terminals
- b) ensure the mechanical (IP degree) protection of the terminal box.

For **flame-proof motors** the cable inlet must be made by complying with the regulations in point 13 of the standard IEC 60079-1. Apertures not used must be closed in accordance with specifications in point 13 of the same standard.

When reassembling the terminal cover, make sure that if there is a seal, and it is in the right place. Flame-proof motors do not have a seal so before reassembling the terminal box it is necessary to replace the layer of grease. The terminal box cover must be tightened to ensure it is properly sealed.

### 2.3.6 Connection of auxiliary parts (Table B)

#### a) thermal protection

Check which type of protection is installed before making connections. If thermistors (PTC) are used, it is necessary to utilize a suitable relay. Do not apply a tension over 6V during the thermistor continuity test.

#### b) anti-condensation heaters

If the motor is fitted with anti-condensation heaters, their power supply must be separated from that of the motor, using the terminals housed in the terminal box.

 **WARNING:** the supply of the heater is always monophasic and the voltage is different from that of the motor. Check that it corresponds to the one indicated on the plate.

#### c) auxiliary ventilation

Connect the supply of the auxiliary ventilation motor separately from that of the main motor.

 **WARNING:** use a device that allows starting and operation of the main motor only when the auxiliary fan is working.

- d) all the above-mentioned operations must be carried out by following the instructions shown on the connection diagram provided with the motor.

### 2.3.7 Fixing to the base

The bolts fixing the motor to the base must be fitted with washers that they ensure adequate load distribution.

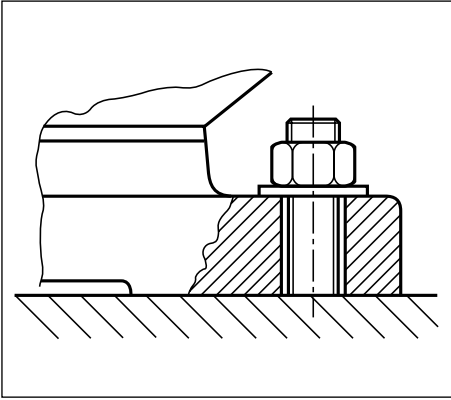



## 3. Putting into operation

 It is the responsibility of the installer to **establish the motor's fitness to be used in a certain plant**, after analysing the characteristics of danger existing in the installation area with respect to current provisions of the law and to those issued for safety purposes.

### 3.1 Initial Controls

Before starting the motor it is important to check that:

- a) installation has been carried out properly
- b) the bearings have not been damaged during installation
- c) the motor base is sturdy enough and the foundation bolts have been tightened
- d) the design data corresponds to those given on the plate and in the technical documentation

 The electric motor is a component made to be mechanically connected to another machine (single or part of a plant). Consequently, it is the task of the person responsible for the installation to **guarantee that during operation there is an adequate degree of protection for people or things against the danger of accidental contact with moving parts**.

### 3.2 Control of Design Data

Make sure that the motor is suited for use in the working conditions foreseen and check the following:

#### 3.2.1 Environmental conditions

- a) ambient temperature: standard closed motors can operate between  $-15\text{ }^{\circ}\text{C}$  and  $+40\text{ }^{\circ}\text{C}$ .  
Standard motors for classified areas (Ex-d, Ex-de, Ex-e, Ex-n) can operate between  $-20\text{ }^{\circ}\text{C}$  and  $+40\text{ }^{\circ}\text{C}$ .
- b) altitude:  
normal motors have been designed to work between 0 and 1.000 m above sea level
- c) protection against the presence of harmful agents like: sand, corrosive substances, dust and/or fibre, water, mechanical stress and vibrations
- d) mechanical protection:  
installation inside or outside considering the harmful effects of the weather, the combined effect of temperature and humidity and the formation of condensation
- e) adequate space around the motor particularly on the fan side to allow proper ventilation

- f) motors mounted in the vertical, shaft down require a protective cowl over the fan inlet
- g) any danger of explosion or fire.

#### 3.2.2 Working conditions

- a) The motor must only be assembled and operated in the construction form indicated on commercial and technical documentation (e.g. acknowledgement, delivery note, invoice, data sheet or drawing).
- b) operation type:  
the motors are normally for S1 duty continuous operation.
- c) load type:  
carefully evaluate machines with high moments of inertia and the relative starting times.
- d) for motors intended for operation in hazardous areas (Ex-d or Ex-e) the motor type and temperature classification must comply with the area rating.  
**When there is an "X" on the plate near the certificate number, it is necessary to check on the certificate which additional conditions are required for proper working.**
- e) for self-braking motors see the special applications envisaged in the relative catalogue.

#### 3.2.3 Electrical characteristics

- a) voltage and frequency should correspond to those on the plate
- b) motor power should be adequate as required by the load
- c) power supply protection against overloads and/or short circuits should be adequate for the nominal current and starting current
- d) for connection to control circuits follow the connection diagram supplied with motor (Table A)

 **Abnormal working conditions must always be defined when placing order** to ensure that the site conditions are not prejudicial to the proper operation of the machine.

#### 3.2.4 Other checks before commissioning

- Check that the motor rotates in the correct direction, and that when the inverter is activated the speed limit is not exceeded.
- Check that the motor is protected as prescribed in the standards.
- Where using a star/delta starter, to avoid the risk of overloading make sure that the switch over from star to delta only takes place when the starting current has been adequately reduced.
- Check that any auxiliary accessories are working.

### 3.3 Starting

#### 3.3.1 Earthing connection

Before starting the motor ensure that the grounding cable is connected.

#### 3.3.2 Motors with auxiliary ventilation

For motors with forced ventilation by means of external ventilation make sure that the motor starter is interlocked with the, contactor of the external ventilator to ensure the fan is operational.

#### 3.3.3 Start up

When all previous checks have been made satisfactorily, the motor may be started. Unless otherwise stated all motors can be direct on line started. **If you intend to start the motor by means of static starters, rheostats or the star-delta system, they must be chosen and set properly to avoid incorrect functioning of the motor.**

### 3.4 Conditions of Use

#### 3.4.1 Working features

Once the motor has started it is necessary to check that during operations the working conditions remain within the limits envisaged, and that the following does not occur:

- a) overload
- b) dangerous rise in environmental temperature
- c) excessive drop in voltage

**Every time there is a change in the working conditions, it is necessary to check that the complete fitness of the motor has been maintained for the new operating conditions.**

For example:

- variation in working cycle
- the function of the motor has altered
- moving of the motor to a different environment (from outside to inside)
- moving of the motor from a low temperature environment to one with a higher temperature.

#### 3.4.2 Restarting after long rest

Before starting the motor after a long resting period, repeat the controls described in section 2.2.2 and 2.2.3.

**Where supplied, heater must not be energised when the motor is running.**

#### 3.4.3 Anomalous conditions

The motor must be used solely for applications it was designed for and must be utilized and controlled complying with the precautionary standards.



** If the machine shows anomalous working characteristics (greater absorption, increase in temperature, noisiness, vibrations), inform the personnel in charge of maintenance immediately.**

#### 3.4.4 Protection against overloading

In terms of the IEC 60079-14 standard all motors are to be protected using a suitable switch, such as one with a delayed trip that is triggered by the current, as well as protection in case of a phase going down. The protective device is to be set at the nominal current shown on the plate. This device must be chosen so that the motor is protected thermally should the rotor jam.

The windings connected in delta must be protected in such a way that the switches or relays are connected in series with the winding phase. Switches are to be chosen and set taking the nominal phase current, that is, 0,58 times the motor's nominal current, as the base value.

## 4. Maintenance

  Any operation on the motor must be carried out with the machine stopped and disconnected from the power supply (including auxiliary circuits, especially the anticondensation heaters). **Maintenance of the original characteristics of electric machines over time must be ensured by a schedule of inspection, maintenance and setting up managed by qualified technicians.** The type and frequency of maintenance depends on environmental and working conditions. As a rule, it is recommended that the first inspection is made after about 500 hours of operations (or, within 1 year), while subsequent inspections should follow the schedules established for lubrication and general inspection.

### 4.1 Inspection

#### 4.1.1 Normal working

Check that the motor works normally without anomalous noise or vibrations. If it does not, locate the cause of the anomaly.

#### 4.1.2 Cleaning the surface

Make sure that the ventilation is not obstructed. Clean the motor by removing any dust or fibre deposits from the fins and from the fan cover.

#### 4.1.3 Checking the supply and earthing cable

Check that the supply cable does not show signs of wear and that the connections are tight. Make sure that the earth and supply cables are not damaged.

#### 4.1.4 Transmission elements

Check that the transmission elements are in perfect condition and that the screws and nuts are tight.

#### 4.1.5 Protection against water

When the motor is installed in a very damp environment or is subject to drips of water, check regularly that the seal and retaining rings and any protective devices work efficiently. Ensure that there are no infiltrations inside the casing or terminal box.

#### 4.1.6 Drainage devices

The motors furnished with drainage devices should be checked and cleaned regularly so that such devices continue to work properly.

#### 4.1.7 Thermal protection

Make sure that thermal protections have not cut out and have been set properly.

 The right selection and setting of thermal protections for Ex-e motors is essential to guarantee the temperature class and safety against the danger of explosion.

#### 4.1.8 Unauthorized modifications

**Check that no modifications have been made that alter the electric and mechanical operation of the motor.**

#### 4.1.9 Painting

When the motor is installed in an environment where there are corrosive agents it is recommended to paint the motor itself to protect the outer surfaces from corrosion if necessary.

#### 4.1.10 Reconditioning operations

**Every irregularity or fault found during inspection must be fixed immediately.**

## 4.2 Lubrication

#### 4.2.1 Permanently lubricated bearings

Motors with shielded or sealed bearings (type ZZ or 2RS) do not require lubrication. Therefore, if used properly, they do not require maintenance.

#### 4.2.2 Bearings with lubricator

Motors with unshielded bearings are furnished with lubricators. The interval time between lubrications depends on the type of grease, environmental temperature, (any excessive working temperature) and type of operation the motor carries out. The table C shows the intervals foreseen for 70 °C as a working temperature of the bearings in normal operating conditions. It is recommended to use a good quality lithium based grease with great penetration capacity and high dropping point like. (Eg. SKF LGHP 2, SKF LGWA 2). If the velocity is different from the one given in the table, the intervals must be modified in inverse proportion.

Eg. bearing 6314 at 1.800 RPM

$$l = \frac{1500}{1800} \times 3550 \text{ h} = 2950 \text{ h}$$

Regardless of working hours, the grease must be renewed after 1 or 2 years or during a complete overhaul. When the motor is furnished with a lubrication plate, refer to the dates shown on it.

## 4.3 Dismantling and Reassembling the Motor

All operations must be carried out bearing in mind health and safety regulations.

### 4.3.1 Consulting the catalogue

Before working on the motor it is advisable to consult the relevant catalogue and have all the tools ready.

### 4.3.2 Disconnection from power supply

Before proceeding with dismantling, the motor must be disconnected from the power supply. Make sure that the power is off disconnect supply cables and auxiliary cables when there are any.

### 4.3.3 Placing on workstand

In order to work on the motor satisfactorily it should be removed from its mounting and placed on a work bench.

### 4.3.4 Dismantling procedure

Take off the fan cover by removing the fixing screws. Using an extractor remove the cooling fan. Remove the end shields and withdraw the rotor being careful not to damage the windings. **Precautions must be taken with flameproof motors so that the spigots on the frame and the end shields are not damaged.** When the motor is dismantling and before it is reassembled it is necessary to protect the various components (particularly the bearings and windings) to avoid damage caused by dust or knocks.

### 4.3.5 Additions for self-braking motors

For dismantling of self-braking motors follow the instructions shown in the relative catalogue.

## 4.4 Replacing the bearings

### 4.4.1 Dismantling of bearings

- Bearings interference fit to shaft: remove the bearings with the aid of a suitable extractor.
- Bearings interference fit to end shield: heat end shield to a temperature between 140 and 160 °C and then remove the bearings with the aid of a suitable extractor.

In both cases, check that the respective housings have not been damaged. Then proceed with fitting the new bearings, these should be identical to those being replaced.

### 4.4.2 Fitting new bearings

- Bearings interference fit to shaft: heat the bearings to 120-130 °C and push them quickly onto the shafts. If required, use a mallet and a brass sleeve, this must rest on the inner race of the

bearing. Alternatively, if it is not possible to heat the bearings, we recommend using a press and a suitable sleeve which must rest on the inner race of the bearing.

- Bearings interference fit to end shield: heat the end shield to a maximum temperature of 140 °C, then position the bearing in its housing, pushing it until it rests against the snap ring (Seeger).

### 4.4.3 Checking the bearings

- Bearings interference fit to shaft: after assembly has been completed the inner ring of the bearing must rest against the relevant shaft shoulder.
- Bearings interference fit to end shield: after assembly has been completed the inner ring of the bearing must rest against the snap ring (Seeger).

### 4.4.4 Reassembling the motor

Before reassembling, clean the internal parts of the motor carefully and check that the components have not been damaged. Renew the layer of grease where needed on the abutting spigots and proceed with the reassembling.

## 4.5 Overhauls and Repairs

### 4.5.1 Spare parts

When needed, all motor components should be replaced by **original spare parts**. To request spare parts use the nomenclature shown in the catalogues and always give:

- motor type
- serial number
- year built

### 4.5.2 Personnel qualification - Authorized repair shops

**Overhauls and repairs must be carried out by trained personnel who guarantee restoration of the motor to its original conditions, we recommend that you contact an authorised repair agent.** For further information please contact our sales department.

## 5. Troubleshooting

Problem	Possible Cause	Solution
The motor does not start	<p>Fuses damaged due to overloading</p> <p>Opening of the overload switch</p> <p>Insufficient power available</p> <p>Connections incorrect</p> <p>Mechanical fault</p> <p>Short circuit on the stator</p> <p>Defective rotor</p> <p>One phase is down</p> <p>Incorrect application</p> <p>Overload</p> <p>Voltage too low</p>	<p>Replace the fuses with similar ones of the correct size.</p> <p>Check and reset the switches.</p> <p>Check that the power required is as shown on the motor's plate.</p> <p>Check that the connections are as shown in the motor's connection diagram.</p> <p>Check that the motor and the machine to which it is coupled turn freely.</p> <p>Check the bearings and lubricant.</p> <p>The motor must be rewound.</p> <p>Check whether the bars and the rings are broken, if necessary replace the rotor.</p> <p>Check the connection cables.</p> <p>Check the sizing with the manufacturer.</p> <p>Reduce the load.</p> <p>Make sure that the motor is powered at the voltage shown on the plate.</p>
The motor does not reach its nominal speed or the acceleration times are too long and/or absorption excessive	<p>Voltage drop on the line</p> <p>Excessive inertia</p> <p>Defective rotor</p>	<p>Check the connections.</p> <p>Check that the cables are of the correct size.</p> <p>Check the size of the motor.</p> <p>Check the state of the rotor cage.</p> <p>Replace the rotor if necessary.</p>

<b>Problem</b>	<b>Possible Cause</b>	<b>Solution</b>
The motor overheats when working under load	Overloaded  Cooling fins and/or fan cover blocked by dirt  One phase on the motor may be down  One phase on the winding is earthed  Phase voltages asymmetrical  Duty too great	Reduce the load.  Clear the ventilation slots to ensure a continuous flow of air over the motor.  Check that all the cables are connected tightly and correctly.  Check the winding and remove the fault.  Check the power supply and motor-voltages and rebalance the loads.  Use the motor for the service indicated on the plate.
Incorrect rotation	Incorrect phase sequence	Invert two phases.
Functioning of the protective device	The motor may have one phase down  Wrong connection  Overloaded	Check the power supply.  Follow the wiring diagram for the connections and the performance data shown on the plate.  Compare against the data on the plate and reduce the load if necessary.
Abnormal vibrations	Motor not aligned  Base weak  Coupling or pulley not balanced  Coupled machine unbalanced  Defective bearings  Motor balanced differently from the coupling (half key – full key)  Three-phase motor working with 1 phase down  Excessive play on the bearings	Align the motor with the machine it controls.  Reinforce the base. Check the bolts.  Balance the device.  Balance the coupled machine.  Replace the bearings.  Balance the coupling using the half key.  Check the phases and reinstate the three-phase system.  Either: - replace the bearings - replace the shield - add a shim to the bearing seating.
Irregular noise	Fan touching the fan cover  Defective bearings	Eliminate contact.  Replace the bearings.

Problem	Possible Cause	Solution
Bearings overheating	Motor fitted incorrectly	Check that the motor is adequate for the type of fitting.
	Belts over-tensioned	Reduce the belt tension.
	Pulleys too far from the shaft shoulder	Move the pulley nearer to the shoulder on the motor shaft.
	Pulley diameter too small	Use a bigger pulley.
	Alignment incorrect	Correct the alignment of the motor and the machine coupled to it.
	Insufficient grease	Keep the correct amount of lubricant in the bearings.
	Lubricant ineffective or contaminated	Remove the old grease, wash contaminated bearings carefully and grease with new lubricant.
	Excessive lubricant	Reduce the amount of lubricant. The bearing must not be more than half full.
	Bearing overloaded	Check the alignment and any radial and/or axial thrust.
Bearing balls or race damaged	Replace the bearing.	

# Connecting diagrams - Table A

## Connection for single speed motors:

Y-Connection

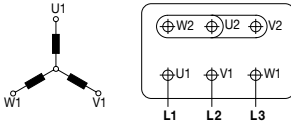

Connection-Δ

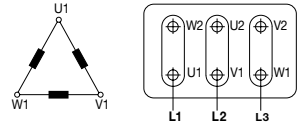

Number of pole: 2, 4, 6, 8 .... - Synchronous speed at 50 Hz: 3000, 1500, 1000, 750 ....

## Two separate windings for two speed motors:

High Speed

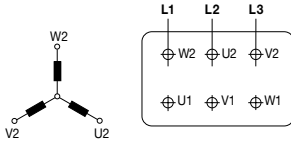

Low Speed

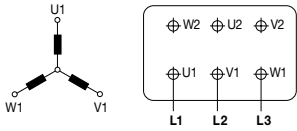

Number of pole: 2/6, 2/8, 4/6, 6/8 .... - Synchronous speed at 50 Hz: 3000/1000, 3000/750, 1500/1000, 1000/750 ....

## Dahlander system for two speed motors, constant torque:

High Speed

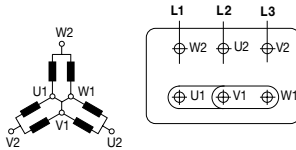

Low Speed

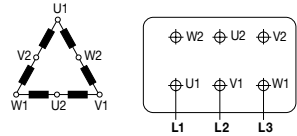

Number of pole: 2/4, 4/8 - Synchronous speed at 50 Hz: 3000/1500, 1500/750

## Dahlander system for two speed motors, quadratic torque:

High Speed

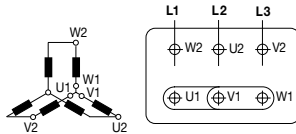

Low Speed

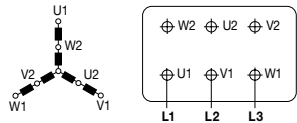

Number of pole: 2/4, 4/8 - Synchronous speed at 50 Hz: 3000/1500, 1500/750

## Connection for single-phase and special motors.

For single-phase motors and motors with special connections, refer to the diagrams provided with the motor.



## Additional terminals marking (IEC60034-8) - Table B

Marking	No. terminals	Additional terminal for:
TP1 - TP2 (warning)	2	Thermistor PTC (*)
TP3 - TP4 (switch off)	2	
R1 - R2 - R3 (I sensor)	3	Thermistor PT 100 with 3 wires
R4 - R5 - R6 (II sensor)	3	
R7 - R8 - R9 (III sensor)	3	Thermistor PT 100 on bearing
R11 - R12 - R13 (DE)	3	
R21 - R22 - R23 (NDE)	3	Normally closed bi-metallic switch (**)
TB1 - TB2 (warning)	2	
TB3 - TB4 (switch off)	2	Normally closed brake bi-metallic switch (**)
TB8 - TB9 (switch off)	2	
TM1 - TM2 (warning)	2	Normally open bi-metallic switch (**)
TM3 - TM4 (switch off)	2	
HE1 - HE2	2	Space heaters
U1 - U2	2	Single phase forced ventilation
U - V - W	2	Three phase forced ventilation
colours according manufacturer diagram	9	Encoder
CA1 - CA2	2	Capacitor
PE	1	Earth cable

(\*) U rated = 6V - max 30V - (\*\*) U rated = 250V

## Lubrication intervals in hours for unshielded bearings - Table C

Bearings	Amount of Grease "in Grammes"	3000 RPM	1500 RPM	1000 RPM	750 RPM
6 205	4	4500	9500	10000	10000
6 206	5	4000	8500	10000	10000
6 306	6.5	3750	8000	10000	10000
6 208	10	2800	6000	9000	10000
6 308	10	2800	6000	9000	10000
6 309 / NU 309	12	5500	8250	11000	11000
6 310 / NU 310	12	2000	-	-	-
6 310 / NU 310	15	-	6000	7000	7000
6 311	17	1800	4500	7500	10000
NU 311	17	950	2350	3750	5000
6 312 / NU 312	12	2100	-	-	-
6 312 / NU 312	15	-	5000	7000	7000
6 313 / NU 313	15	2000	-	-	-
6 313 / NU 313	18	-	4500	5600	6400
6 314 / NU 314	20	-	4100	5300	6200
6 316 / NU 316	33	2900	4300	4600	4800
7316	33	900	3150	5600	8000
3 316	58	-	3150	5600	8000
6 317 / NU 317	37	-	7800	7800	13600
3318/7318	41	-	2650	5000	7100
3 318	70	-	2650	5000	7100
NU 318	41	-	1400	2650	3550
6320/7320	51	-	2360	4500	6300
3 320	90	-	2360	4500	6300
NU 320	51	-	1180	2360	3350

Use the data shown on the motor's plate (see also catalogue).

Nel redigere questa documentazione è stata posta ogni cura al fine di assicurare la correttezza delle informazioni contenute.

Tuttavia, anche in conseguenza della politica di continuo sviluppo e miglioramento della qualità del prodotto perseguita da **Cemp**, la società si riserva il diritto e la facoltà di apportare modifiche di qualsiasi genere, in qualsiasi momento e senza preavviso, sia a questo documento sia ai propri prodotti.

Le descrizioni e le caratteristiche tecniche della presente pubblicazione non sono quindi impegnative e i dati riportati non costituiscono, in nessun caso, impegno contrattuale.

Every care has been taken to ensure the accuracy of the information contained in this publication.

Due to **Cemp's** policy of continuous development and improvement, the company reserves the right to supply products which may differ slightly from those illustrated and described in this publication.

Descriptions and technical features listed in this brochure may not be considered as binding. Under no circumstances should data in this publication be considered as a contractual obligation.

Dans la préparation de cette documentation nous avons pris le soin d'y intégrer les informations les plus exactes possibles.

Néanmoins, compte tenu de notre politique de développement et d'amélioration continue des produits, la Société **Cemp** se réserve le droit et la faculté d'apporter toute modification sur la documentation et sur les produits, à tout moment et sans préavis.

Les descriptifs et les caractéristiques techniques contenus dans ce catalogue n'engagent pas la Société. Par conséquent, ces données ne constituent en aucun cas un engagement contractuel.

Die Ausführungen und technischen Eigenschaften, die in dieser Broschüre angegeben sind, dürfen nicht als verbindlich angesehen werden.

In keinem Fall können jedoch die in diesem Dokument aufgeführten technischen Daten als rechtlich verbindlich angesehen werden.

**Cemp** behält sich das Recht vor, ohne Mitteilung, jegliche Abweichungen und Änderungen jederzeit vorzunehmen, sowohl in diesem Dokument als auch bei den Produkten, die hier beschrieben sind.

La presente documentación se ha redactado de manera muy atenta para poder asegurar que las informaciones que contiene son correctas.

No obstante, como consecuencia de la política de continuo desarrollo y mejora de la calidad del producto que **Cemp** pone en práctica, la sociedad se reserva el derecho y la facultad de modificar en lo que fuera necesario, en cualquier momento y sin que para ello medie preaviso alguno, tanto este documento como sus productos.

Por lo tanto, las descripciones y las características técnicas indicadas en el presente documento no son vinculantes, y los datos que contiene no constituyen en ningún caso, vínculo contractual.

# **cemp**<sup>®</sup>

Flameproof  
Motors

## **HEADQUARTER**

### **Cemp srl**

Via Piemonte, 16  
20030 Senago (Milano) - Italy  
Tel. +39 02 94435401  
Fax +39 02 9989177  
info@cemp.eu

[www.cemp.eu](http://www.cemp.eu) - [www.regalbeloit.com](http://www.regalbeloit.com)

---

## **BRANCHES**

### **Germany**

Dr. Atzinger-Strasse 5  
94036 Passau - Germany  
Tel. +49 (0)851 9662320  
Fax +49 (0)851 96623213  
cemp-deutschland@cemp.eu

---

## **OFFICES**

### **France**

14 rue des Cours Neuves,  
77135 Pontcarré - France  
Phone +33 01 64660548  
Fax +33 01 64660582  
cemp-france@cemp.eu

---

### **Dubai**

GT3, Office 001  
Jebel Ali Free Zone - Dubai - UAE  
Phone +971 4 8812666  
Fax +971 4 8812662  
cemp-uae@cemp.eu

---

A Regal Brand

**REGAL**<sup>®</sup>